

Chest Freezer Side View

FREEZER SPECIFICATIONS		
CAPACITY	12 CUBIC FEET	
STYLE	CHEST	
NET WEIGHT	700 LBS.	
SHIPPING WEIGHT	750 LBS.	
INTERIOR DIMENSIONS		
INTERIOR WIDTH	55.0"	(139.7 cm)
INTERIOR DEPTH	19.0"	(48.3 cm)
INTERIOR HEIGHT	20.0"	(50.8 cm)
EXTERIOR DIMENSIONS		
EXTERIOR WIDTH	65.5"	(166.3 cm)
EXTERIOR DEPTH	32.0"	(81.2 cm)
EXTERIOR HEIGHT	47.5"	(120.6 cm)
EXTERIOR CRATED DIMENSIONS		
CRATED WIDTH	72.0"	(182.8 cm)
CRATED DEPTH	41.0"	(104.1 cm)
CRATED HEIGHT	57.0"	(144.8 cm)

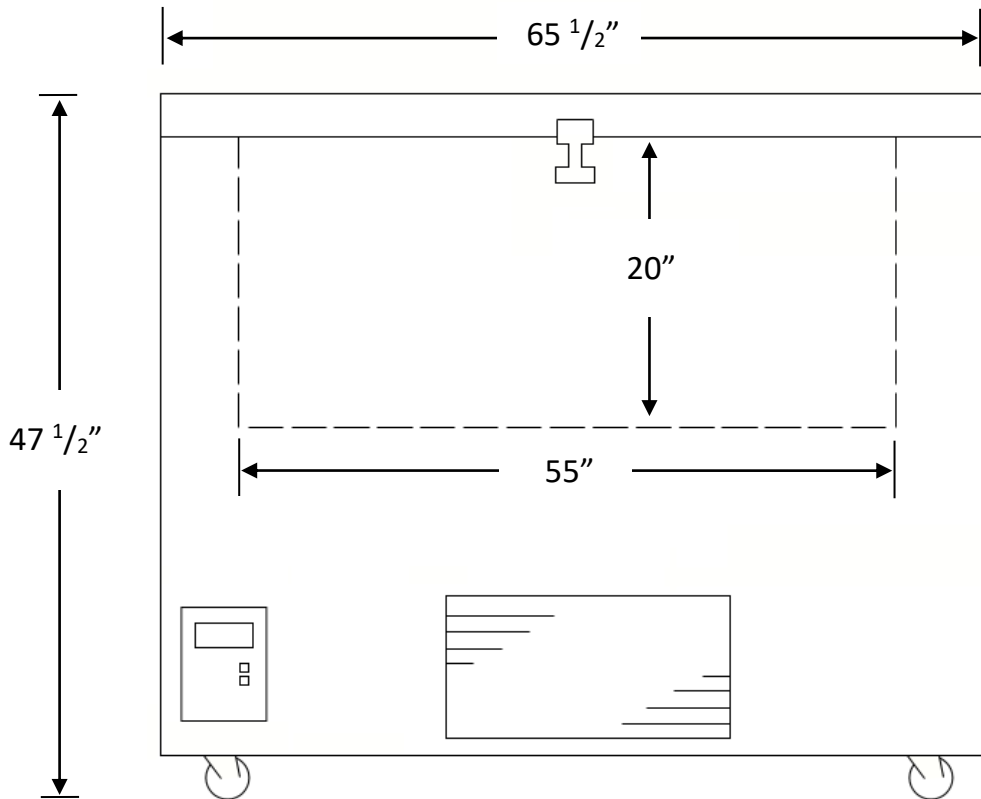

Chest Freezer Front View