

Chest Freezer Side View

FREEZER SPECIFICATIONS		
CAPACITY	2 CUBIC FEET	
STYLE	CHEST	
NET WEIGHT	300 LBS.	
SHIPPING WEIGHT	400 LBS.	
INTERIOR DIMENSIONS		
INTERIOR WIDTH	17.0"	(43.1 cm)
INTERIOR DEPTH	14.0"	(35.5 cm)
INTERIOR HEIGHT	14.0"	(35.5 cm)
EXTERIOR DIMENSIONS		
EXTERIOR WIDTH	25.25"	(64.1 cm)
EXTERIOR DEPTH	25.75"	(65.4 cm)
EXTERIOR HEIGHT	40.0"	(101.6 cm)
EXTERIOR CRATED DIMENSIONS		
CRATED WIDTH	32.0"	(81.2 cm)
CRATED DEPTH	32.0"	(81.2 cm)
CRATED HEIGHT	46.0"	(116.8 cm)

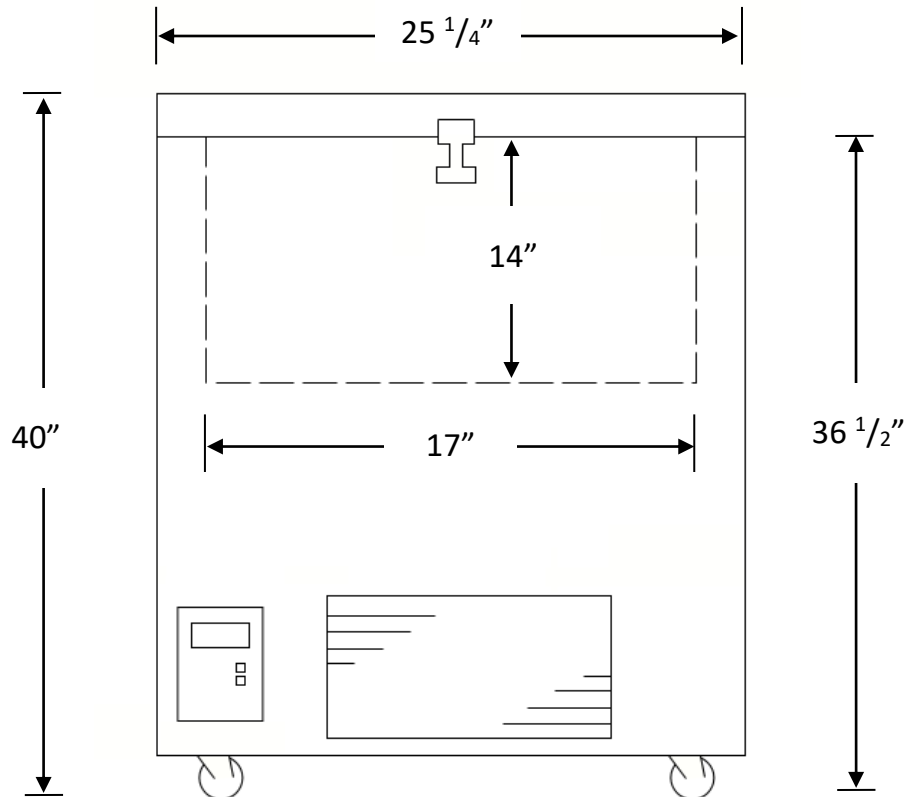

Chest Freezer Front View