

Upright Freezer Top View

FREEZER SPECIFICATIONS		
CAPACITY	28 CUBIC FEET	
STYLE	UPRIGHT	
NET WEIGHT	1000 LBS.	
SHIPPING WEIGHT	1225 LBS.	
INTERIOR DIMENSIONS		
INTERIOR WIDTH	38.0"	(96.52 cm)
INTERIOR DEPTH	25.0"	(63.5 cm)
INTERIOR HEIGHT	51.25"	(130 cm)
EXTERIOR DIMENSIONS		
EXTERIOR WIDTH	54.0"	(137.1 cm)
EXTERIOR DEPTH	37.0"	(93.9 cm)
EXTERIOR HEIGHT	79.5"	(201.9 cm)
EXTERIOR CRATED DIMENSIONS		
CRATED WIDTH	68.0"	(172 cm)
CRATED DEPTH	45.0"	(114 cm)
CRATED HEIGHT	85.0"	(218 cm)

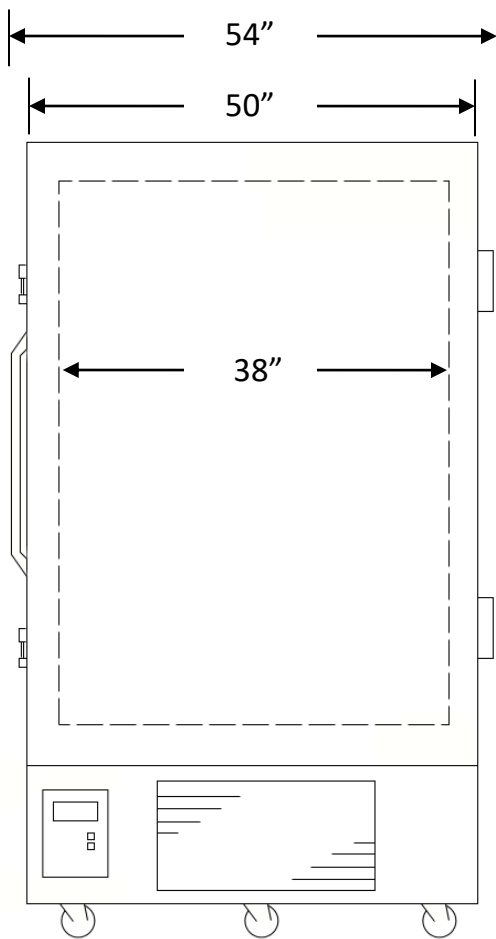

Upright Freezer Front View

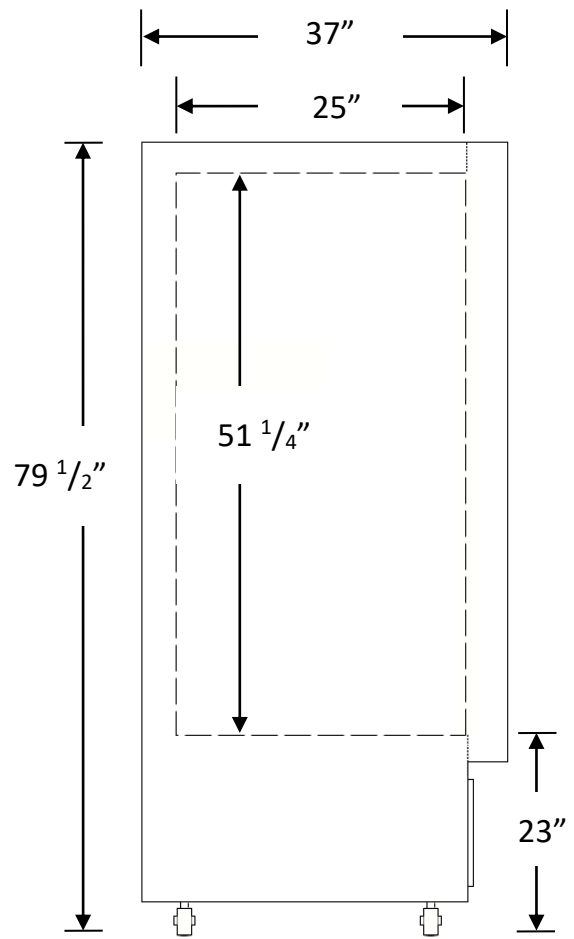

Upright Freezer Side View