

MODEL C80-21

21 CUBIC FOOT ULTRA LOW TEMPERATURE FREEZER

	WIDTH	DEPTH	HEIGHT	WIDTH	DEPTH	HEIGHT
INTERIOR DIMENSIONS	81 IN	21.5 IN	21 IN	205 CM	54 CM	53 CM
EXTERIOR DIMENSIONS	91 IN	36 IN	49 IN	231 CM	91 CM	124 CM
CRATED DIMENSIONS	101 IN	43 IN	53 IN	256 CM	109 CM	134 CM

NOTE THAT THE FREEZER LID CAN OPEN UP TO APPROXIMATELY 75° FROM HORIZONTAL POSITION

SIDE VIEW

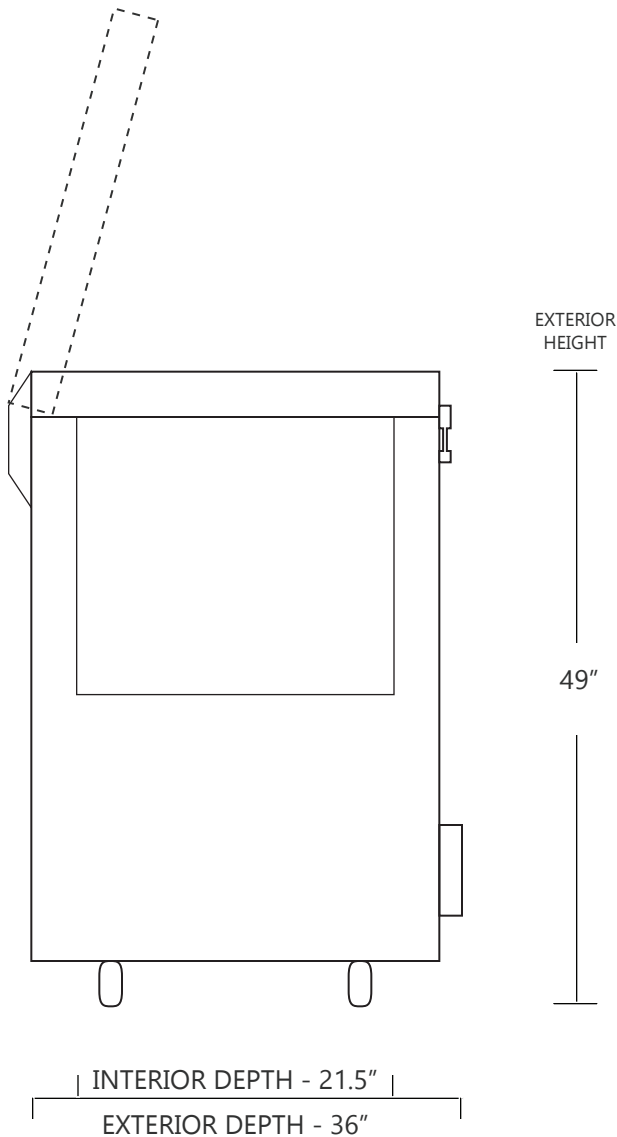

FRONT VIEW

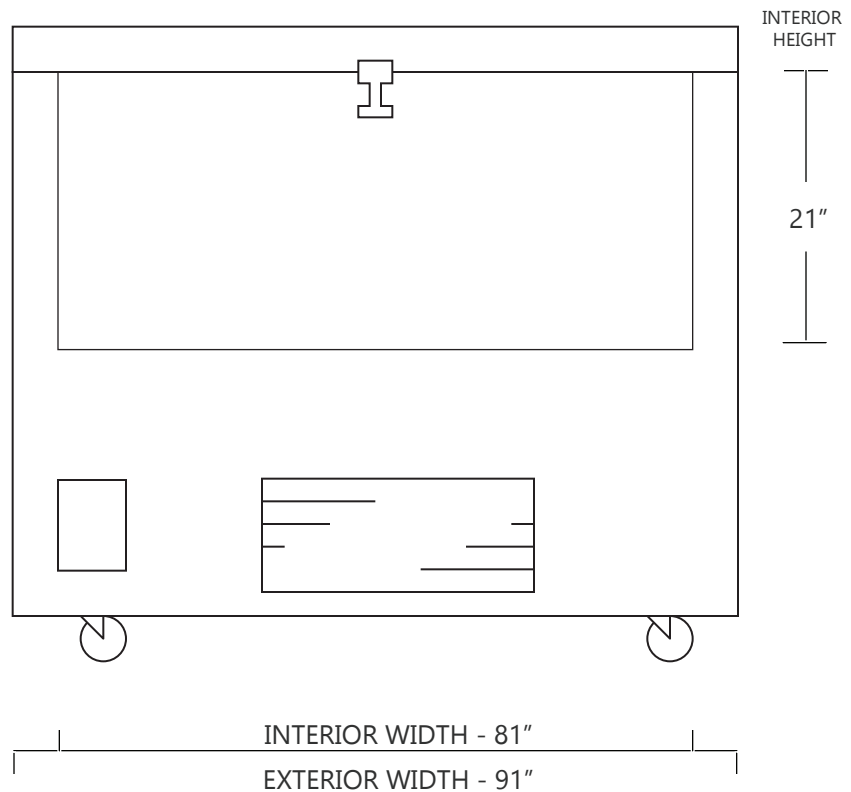

SO-LOW

WWW.SO-LOW.COM



NET WEIGHT : 850 LBS.
SHIPPING WEIGHT: 1075 LBS.

SHIPPING OPTIONS

DOCK-TO-DOCK DELIVERY (REQUIRES FORKLIFT OR PALLET JACK)
INSIDE / WHITE GLOVE DELIVERY (REQUIRES A SEMI-TRUCK RECEIVING DOCK)