

MODEL C85-12

12 CUBIC FOOT ULTRA LOW TEMPERATURE FREEZER

	WIDTH	DEPTH	HEIGHT	WIDTH	DEPTH	HEIGHT
INTERIOR DIMENSIONS	55 IN	19 IN	20 IN	139 CM	48 CM	50 CM
EXTERIOR DIMENSIONS	65.5 IN	32 IN	47.5 IN	166 CM	81 CM	120 CM
CRATED DIMENSIONS	70 IN	41 IN	57 IN	177 CM	101 CM	139 CM

NOTE THAT THE FREEZER LID CAN OPEN UP TO APPROXIMATELY 75° FROM HORIZONTAL POSITION

SIDE VIEW

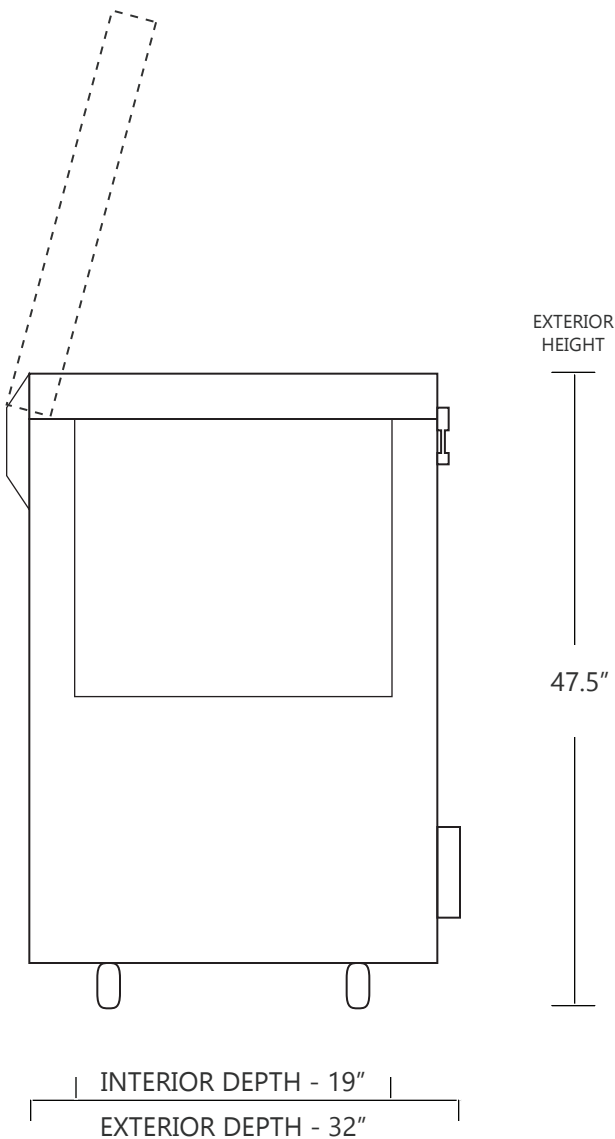

FRONT VIEW

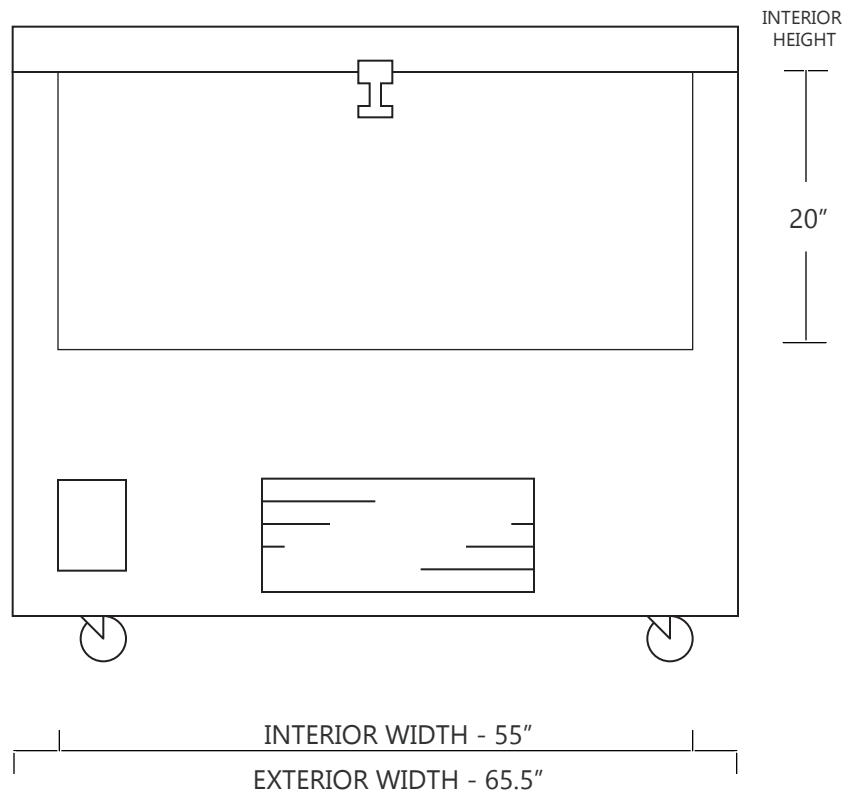

SO-LOW

WWW.SO-LOW.COM



NET WEIGHT : 650 LBS.
SHIPPING WEIGHT: 825 LBS.

SHIPPING OPTIONS

DOCK-TO-DOCK DELIVERY (REQUIRES FORKLIFT OR PALLET JACK)
DOCK-TO-DOCK DELIVERY WITH LIFTGATE (REQUIRES FORKLIFT OR PALLET JACK)
INSIDE DELIVERY (WHITE GLOVE DELIVERY)