

MODEL C85-9

9 CUBIC FOOT ULTRA LOW TEMPERATURE FREEZER

	WIDTH	DEPTH	HEIGHT	WIDTH	DEPTH	HEIGHT
INTERIOR DIMENSIONS	45.5 IN	16 IN	20 IN	115 CM	40 CM	50 CM
EXTERIOR DIMENSIONS	57.5 IN	29 IN	46.5 IN	146 CM	73 CM	116 CM
CRATED DIMENSIONS	62 IN	40 IN	55 IN	157 CM	101 CM	139 CM

NOTE THAT THE FREEZER LID CAN OPEN UP TO APPROXIMATELY 75° FROM HORIZONTAL POSITION

SIDE VIEW

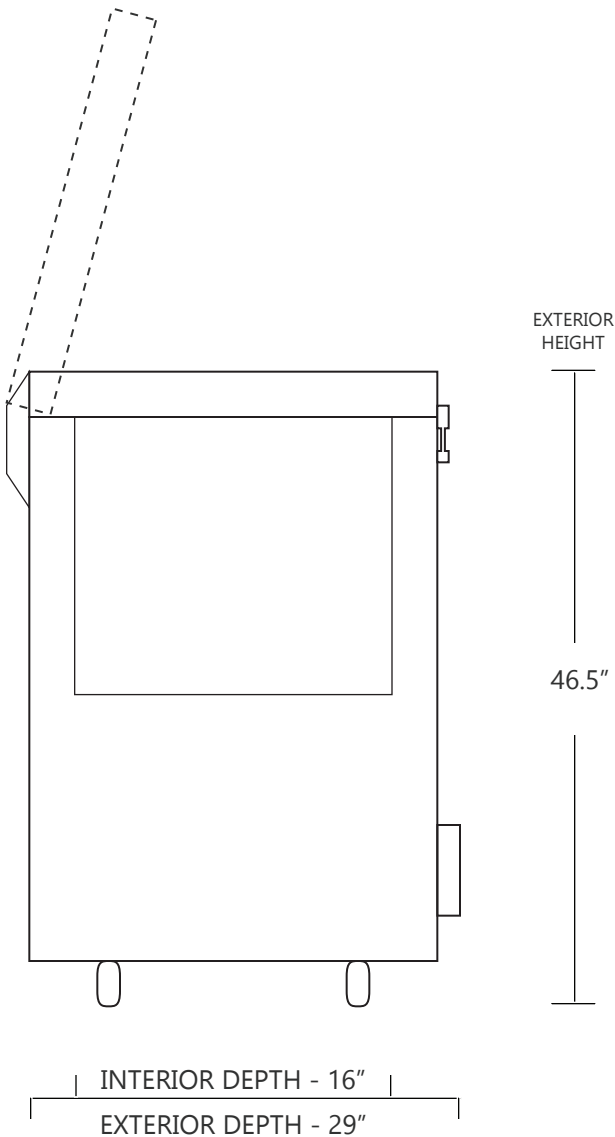

FRONT VIEW

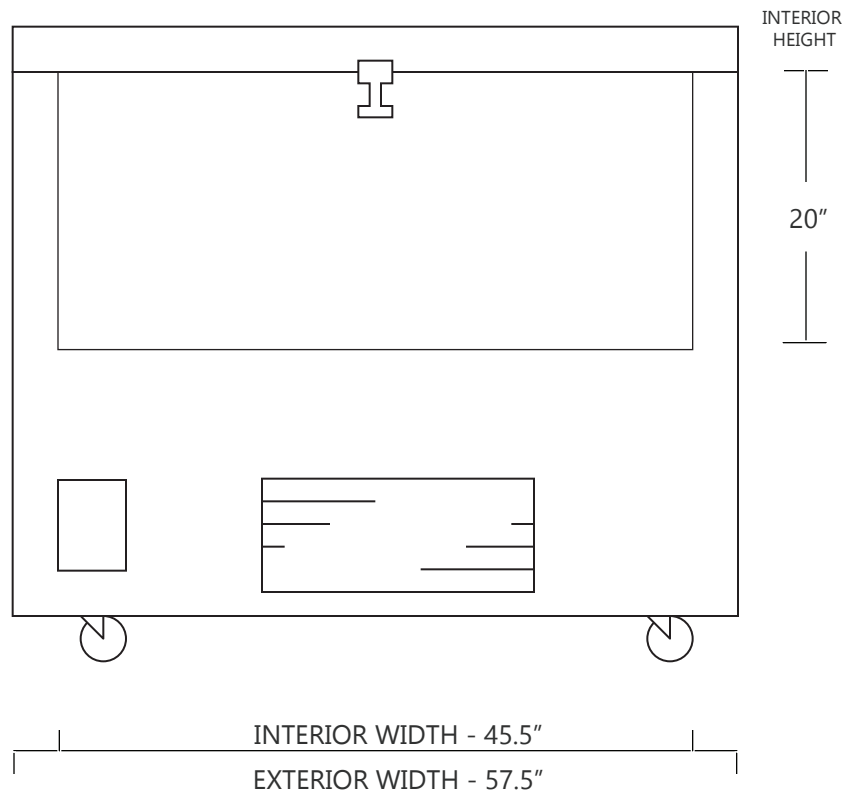

SO-LOW

WWW.SO-LOW.COM



NET WEIGHT : 500 LBS.
SHIPPING WEIGHT: 675 LBS.

SHIPPING OPTIONS

DOCK-TO-DOCK DELIVERY (REQUIRES FORKLIFT OR PALLET JACK)
DOCK-TO-DOCK DELIVERY WITH LIFTGATE (REQUIRES FORKLIFT OR PALLET JACK)
INSIDE DELIVERY (WHITE GLOVE DELIVERY)