

MODEL CH45-3

3 CUBIC FOOT LABORATORY CHEST FREEZER

	WIDTH	DEPTH	HEIGHT	WIDTH	DEPTH	HEIGHT
INTERIOR DIMENSIONS	15.75 IN	17 IN	25.87 IN	40 CM	43 CM	65 CM
EXTERIOR DIMENSIONS	22 IN	23.5 IN	34 IN	55 CM	59 CM	86 CM
CRATED DIMENSIONS	32 IN	32 IN	46 IN	81 CM	81 CM	116 CM

NOTE THAT THE FREEZER LID CAN OPEN UP TO APPROXIMATELY 75° FROM HORIZONTAL POSITION

SIDE VIEW

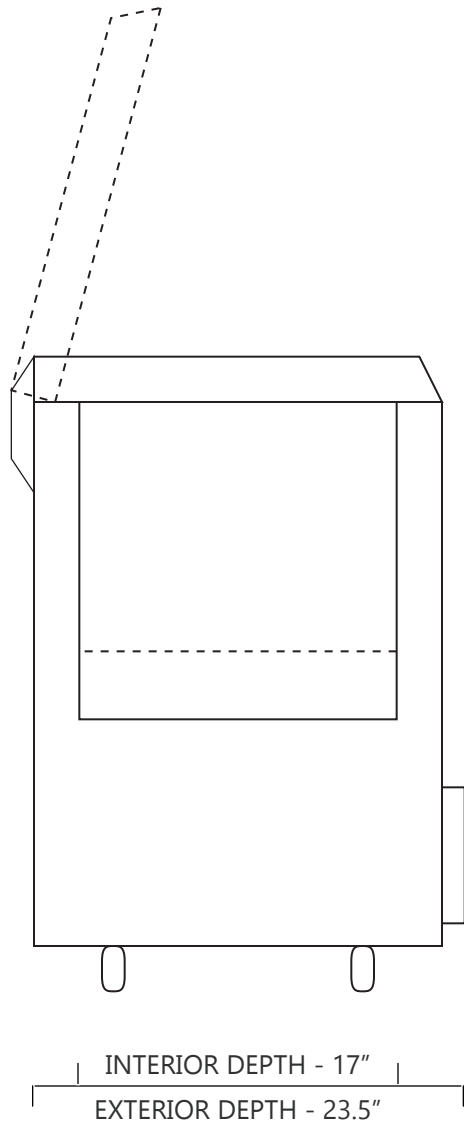

FRONT VIEW

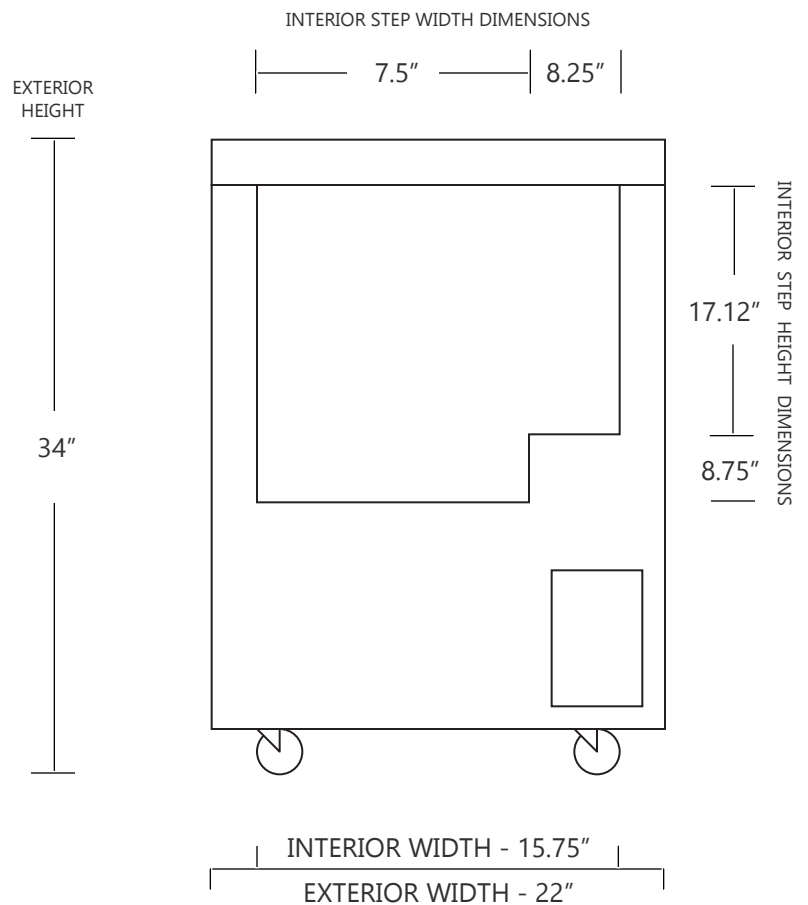

SO-LOW

WWW.SO-LOW.COM



NET WEIGHT : 125 LBS.
SHIPPING WEIGHT: 150 LBS.

SHIPPING OPTIONS

DOCK-TO-DOCK DELIVERY (REQUIRES FORKLIFT OR PALLET JACK)
DOCK-TO-DOCK DELIVERY WITH LIFTGATE (ON PALLET)