

# MODEL NC40-3

## 3 CUBIC FOOT ULTRA LOW TEMPERATURE FREEZER

	WIDTH	DEPTH	HEIGHT	WIDTH	DEPTH	HEIGHT
INTERIOR DIMENSIONS	24 IN	12 IN	18 IN	60 CM	30 CM	45 CM
EXTERIOR DIMENSIONS	34.5 IN	25.25 IN	48 IN	87 CM	64 CM	121 CM
CRATED DIMENSIONS	46 IN	41 IN	55 IN	116 CM	104 CM	139 CM

NOTE THAT THE FREEZER LID CAN OPEN UP TO APPROXIMATELY 75° FROM HORIZONTAL POSITION

### SIDE VIEW

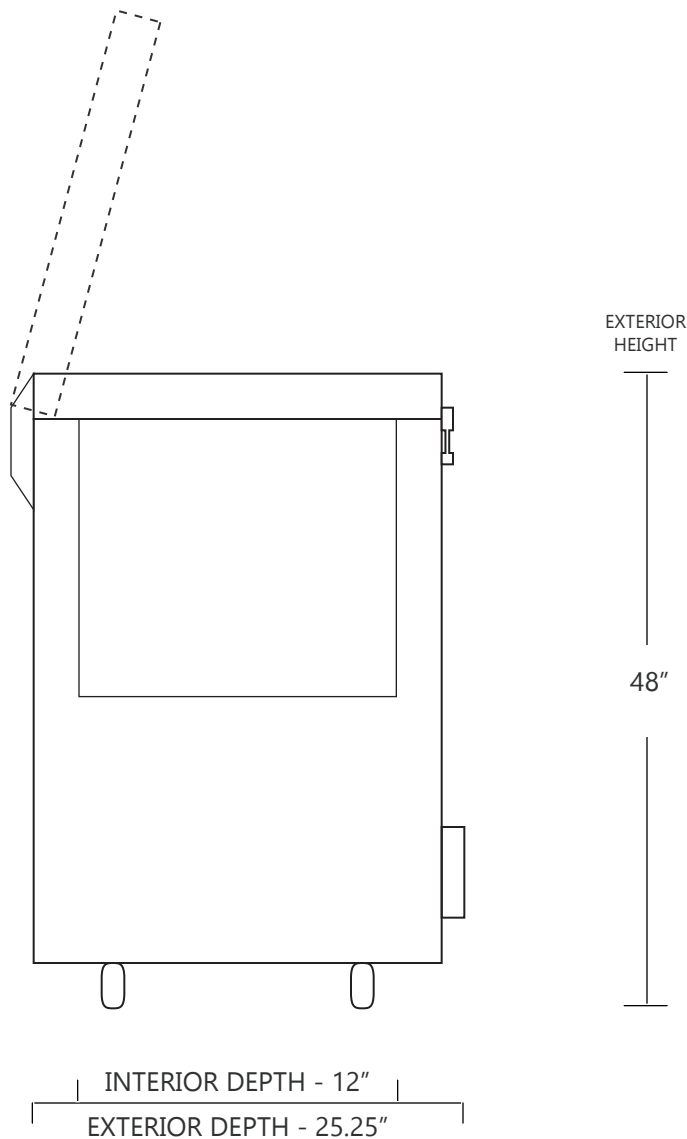

### FRONT VIEW

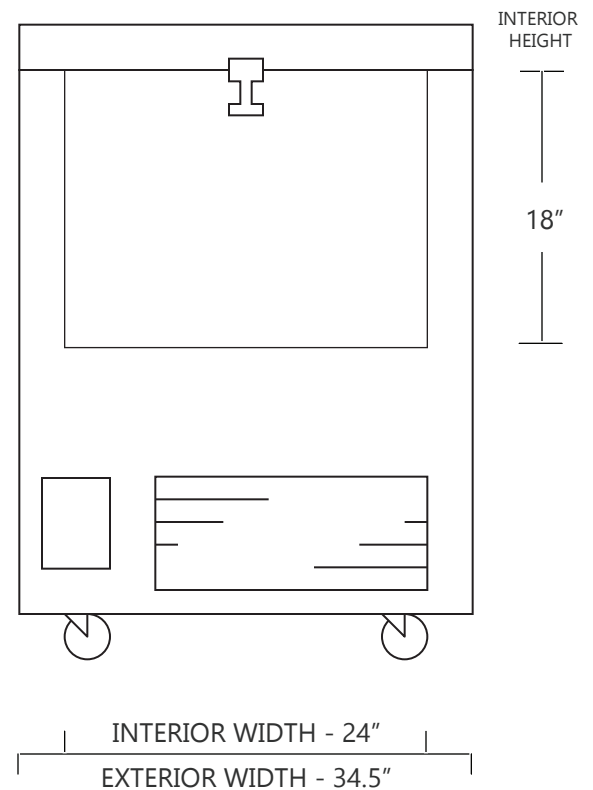

# SO-LOW

[WWW.SO-LOW.COM](http://WWW.SO-LOW.COM)



**NET WEIGHT : 350 LBS.**  
**SHIPPING WEIGHT: 500 LBS.**

### SHIPPING OPTIONS

DOCK-TO-DOCK DELIVERY ( REQUIRES FORKLIFT OR PALLET JACK )  
DOCK-TO-DOCK DELIVERY WITH LIFTGATE ( REQUIRES FORKLIFT OR PALLET JACK )  
INSIDE DELIVERY ( WHITE GLOVE DELIVERY )