

## INSTRUCTIONS: SINGLE STAGE FREEZER

### 1.1 RANGE OF ENVIRONMENTAL CONDITIONS FOR WHICH THIS EQUIPMENT IS DESIGNED

1. Indoor use.
2. Altitude up to 2000m.
3. Temperatures 15°C to 32°C ( 60°F TO 85°F )
4. Recommended humidity range of 30% to 90%.
5. Mains supply fluctuations up to -5% to +10% of the nominal voltage.
6. Transient overvoltages typically present on the mains supply (overvoltage category II). Pollution degree 1.



**CAUTION! THIS FREEZER IS PROVIDED WITH AN INPUT CIRCUIT PROTECTIVE DEVICE WHICH SHALL BE MAINTAINED AND SERVICED BY QUALIFIED PERSONNEL ONLY.**



FUSES OR BREAKERS USED INSIDE PROTECTIVE DEVICE  
15A OR 20A 250V TIME DELAY

**WARNING! UPLUG FREEZER BEFORE ANY TECHNICAL SERVICE IS PREFORMED ON THE UNIT!**



**CAUTION! DO NOT POSITION EQUIPMENT SO IT IS DIFFICULT TO DISCONNECT FROM THE POWER SUPPLY.**

### 1.2 STARTING INSTRUCTIONS

1. Plug the freezer into the proper outlet with an adequate power supply.
2. Confirm the freezer has at least 6" of air space on each side, for air circulation.
3. Turn the refrigeration switch (located in back of unit) to the **ON position** (if applicable).
4. The compressor(s) will start to operate and pull down to the set point on the temperature control.
5. When the freezer reaches the set point, the compressor(s) will cycle on and off to maintain the set point desired by the user on the temperature control.

### 1.3 CLEANING PROCEDURE

1. Wipe down the exterior of the freezer with a soft cloth and spray type polish.
2. If frost builds up in the chamber, a bucket and ice-scraper can be used to remove the ice. If excessive ice builds up, the unit can be defrosted (see below).

### 1.4 DEFROST PROCEDURE

1. Remove any product in the freezer and store it in a back-up freezer or elsewhere.
2. Unplug the freezer, and open the freezer front door / lid.  
**For upright units, use a cloth to protect the control from dripping water.**
3. Air out the freezer for at least 12 hours, allowing the unit to reach room temperature.
4. Take a rag and wipe up all the excess water in the unit (melted frost).
5. Plug the unit in and set your temperature to the desired setpoint
6. Once the desired temperature is reached, add product back into the unit.

**NOTE: It is recommended to slowly re-add your product into the freezer to prevent an extreme load on the compressors, which could shorten freezer life expectancy.**

### 1.5 AUTOMATIC STARTING SYSTEM

The automatic starting system is provided on all freezer systems in case of power failure. If there is an electrical power interruption to the unit and power is not restored immediately, the unit will automatically start up whenever power is returned.





**ATTENTION: Always leave the refrigeration switch in ON position, as this will automatically activate the automatic starting system.**

Single Stage
After power restoration, the single stage will start to operate and begin to pull down to setpoint temperature.



**CAUTION! COVER SCREEN ON BACK OF FREEZER TO BE REMOVED BY AUTHORIZED PERSONNEL ONLY. FOR CONNECTIONS TO THE EXTERNAL ALARM COVER SCREEN MUST BE REPLACED BEFORE PUTTING FREEZER INTO SERVICE. FAILURE TO REINSTALL COVER COULD RESULT IN HAZARD.**

## 1.6 WARNING SYMBOLS



	BLACK WITH YELLOW BACKGROUND	LIGHTNING BOLT	CAUTION: RISK OF ELECTRICAL SHOCK
	BLACK WITH YELLOW BACKGROUND	EXCLIMATION POINT	CAUTION: REFER TO ACCOMPANYING DOCUMENTS

## 1.7 TEMPERATURE CONTROL

The temperature control is manually adjustable to the desired temperature in 1° C increments within the limits of the control range.

	<b>WARNING</b>	
Unauthorized entry into this control will void warranty.		

PARTLOW NO. 1160, FDC 4100, FDC 4000  
ELECTRONIC CONTROL

**NOTE: USE ONLY THE “UP” AND “DOWN” KEYS   WHEN MAKING CHANGES ON THIS CONTROL. WARRANTY WILL BE VOID IF USED IN ANY OTHER WAY. CONTACT FACTORY FOR ALL OTHER ADJUSTMENTS IN SETTINGS.**

**TEMPERATURE SET POINT:** The control has two displays, the upper display is the actual chamber temperature and the lower display is the temperature set point. The temperature set point has been preset at the factory.

**CHANGING TEMPERATURE SET POINT:** The temperature set point can be changed by simply pressing the “up” arrow to raise or the “down” arrow to lower the temperature set point.

## 1.8 ALARM SYSTEM

MODEL	OPERATION INSTRUCTIONS
<b>FDC 4000</b>	Alarm will <u>automatically</u> activate when the freezer reaches set point or 8 hours after the unit has been first plugged in.
<b>FDC 4100</b>	Manually activate the alarm by moving the toggle switch to the on position once the freezer reaches setpoint.
<b>PARTLOW 1160</b>	Manually activate the alarm by moving the toggle switch to the on position once the freezer reaches setpoint.

The alarm will not sound again until the temperature varies 12°C (20°F) from the temperature control set point. Please note that the alarm will sound if there is a power outage to the freezer.



**Alarm system should be tested every 30 days.**

- Non-rechargeable batteries should be changed approximately every two years.
- Rechargeable batteries should be changed approximately every three years with lead acid rechargeable 1.2 Ah min, model *PS-640F1* or equivalent.

## 1.9 ALARM BATTERY TESTING

If applicable, the alarm switch has a test position that can be used anytime to see if the battery is charged or if the buzzer is working properly.

### OPTIONAL EQUIPMENT – DRY CONTACT ALARM RELAY

Located on the back of the freezer is a terminal strip marked ALARM RELAY CONTACTS. Rating of this connection:

<i>ALARM RELAY CONTACTS CONNECTION RATING</i>		
<b>PARTLOW 1160</b>	<b>FDC 4100</b>	<b>FDC 4000</b>
10A 250VAC	10A 250VAC	2A 125 VAC
10A 30VDC	10A 30VDC	2A 30 VDC

RED – NORMALLY CLOSED

WHITE – COMMON

BLUE – NORMALLY OPEN



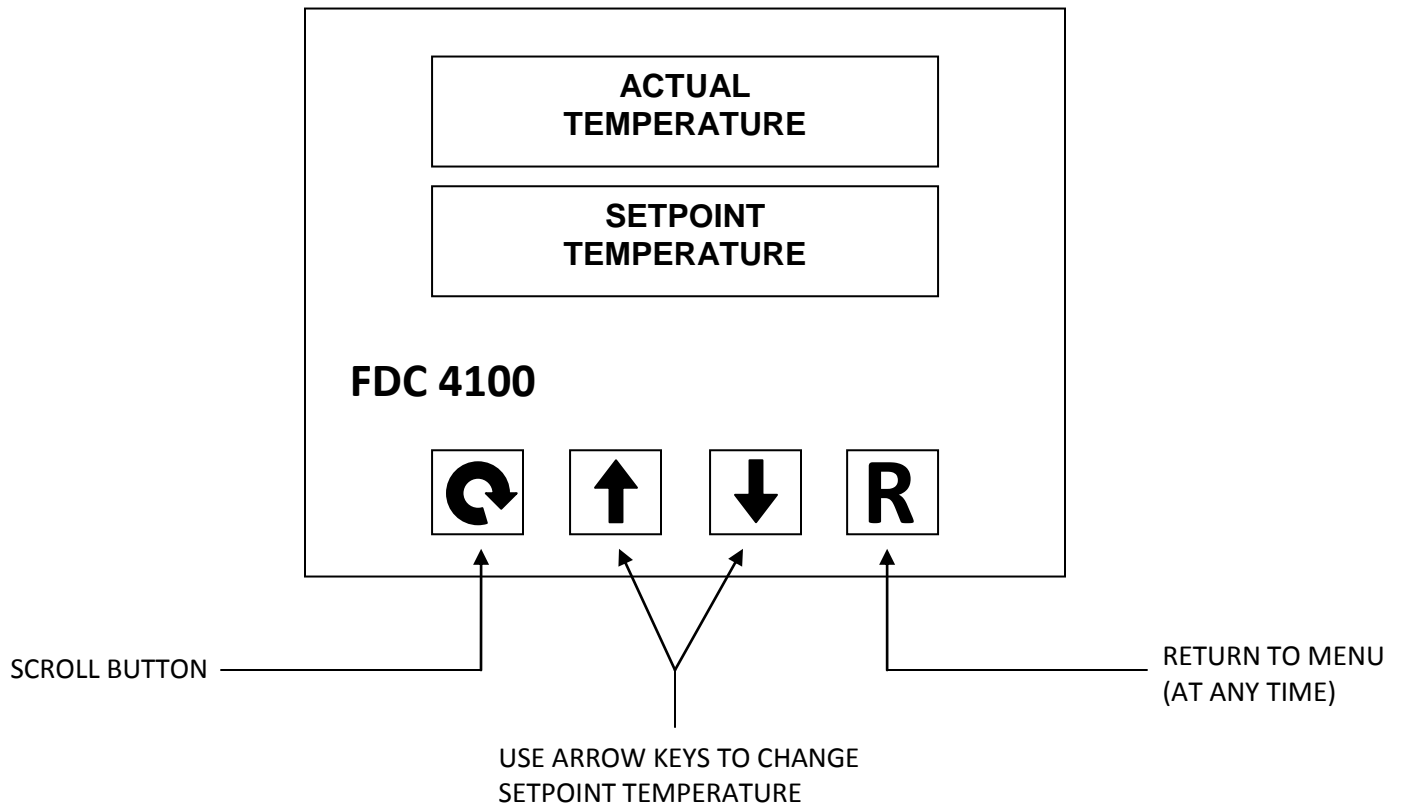

**CAUTION! IF IT IS NECESSARY TO REMOVE METAL COVER SCREEN ON BACK OF FREEZER TO MAKE CONNECTIONS TO ALARM RELAY, COVER MUST BE REPLACED BEFORE FREEZER IS PUT INTO OPERATION**

## FDC 4100 CONTROL





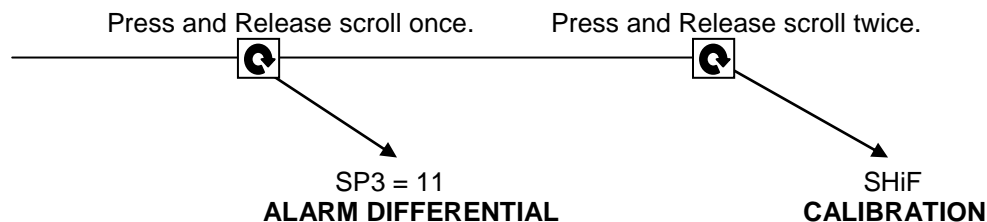

### USER MODE

- To enter USER MODE; **Press and Release** the scroll key .
- To page through user mode Parameters; **Press and Release** the scroll key .









# PROGRAM MODE















- To enter PROGRAM MODE; **Press** and **HOLD** the scroll key  until **SET** shows up.
- To page through user mode Parameters; **Press** and **Release** the scroll key .
- To adjust parameter SETTINGS; **Press** the up  and down  keys .

PARAMETER	SETTING	DESCRIPTION / NOTATION
-----------	---------	------------------------

HOLD SCROLL  
TO ENTER MODE

	SET	----	
PRESS SCROLL 	LOCK	NONE	Change to "ALL" to Lock-Out setpoint
	INPT	t_tc	
	Unit	°C or (°F)	<b>Temperature Scale</b>
	DP	NO.DP	
	SPLL	-100°C (-150°F)	<b>Single Stage Unit Setting is -67°C ( -67°F )</b>
	SPIH	-40°C (-40°F)	<b>Single Stage Unit Setting is 0°C ( 32°F )</b>

**NOTE: The SPLL and SPIH parameters automatically change between °C and °F when this setting is changed in the UNIT parameter.**

	SHIF	??	<b>Calibration</b>
	FILT	0.5	
	PB	0.0	
	OUT1	DIRT	
	O1.TY	RELY	
	O1.FT	ON	
	O1.HY	1.5	<b>Change to 1.0 or 0.7 Hysteresis to tighten cycle</b>
	RAMP	NONE	
	OUT2	NONE	
	AL.FN	Db.Hi	
	AL.ND	NORM	
	AL.FT	OFF	
	CONN	NONE	
	SEL1	SHIF	

# Table A.1 Error Codes and Corrective Actions

Error Code	Display Symbol	Error Description	Corrective Action
4	<i>Er 04</i>	Illegal setup values been used: Before COOL is used for OUT2, DIRT ( cooling action ) has already been used for OUT1 , or PID mode is not used for OUT1 ( that is PB = 0, and / or TI = 0 )	Check and correct setup values of OUT2, PB, TI and OUT1 . IF OUT2 is required for cooling control, the control should use PID mode ( PB $\neq$ 0, TI $\neq$ 0 ) and OUT1 should use reverse mode (heating action) , otherwise, don't use OUT2 for cooling control.
10	<i>Er 10</i>	Communication error: bad function code	Correct the communication software to meet the protocol requirements.
11	<i>Er 11</i>	Communication error: register address out of range	Don't issue an over-range register address to the slave.
14	<i>Er 14</i>	Communication error: attempt to write a read-only data or a protected data	Don't write a read-only data or a protected data to the slave.
15	<i>Er 15</i>	Communication error: write a value which is out of range to a register	Don't write an over-range data to the slave register.
26	<i>AtEr</i>	Fail to perform auto-tuning function	<ol style="list-style-type: none"> <li>1. The PID values obtained after auto-tuning procedure are out of range. Retry auto-tuning.</li> <li>2. Don't change set point value during auto-tuning procedure.</li> <li>3. Use manual tuning instead of auto-tuning.</li> <li>4. Don't set a zero value for PB.</li> <li>5. Don't set a zero value for TI.</li> <li>6. Touch RESET key</li> </ol>
29	<i>EEPE</i>	EEPROM can't be written correctly	Return to factory for repair.
30	<i>CJEr</i>	Cold junction compensation for thermocouple malfunction	Return to factory for repair.
39	<i>SbEr</i>	Input sensor break, or input current below 1 mA if 4-20 mA is selected, or input voltage below 0.25V if 1 - 5V is selected	Replace input sensor.
40	<i>AdEr</i>	A to D converter or related component(s) malfunction	Return to factory for repair.

ENGINEERS AND MANUFACTURERS OF ULTRA-LOW FREEZERS

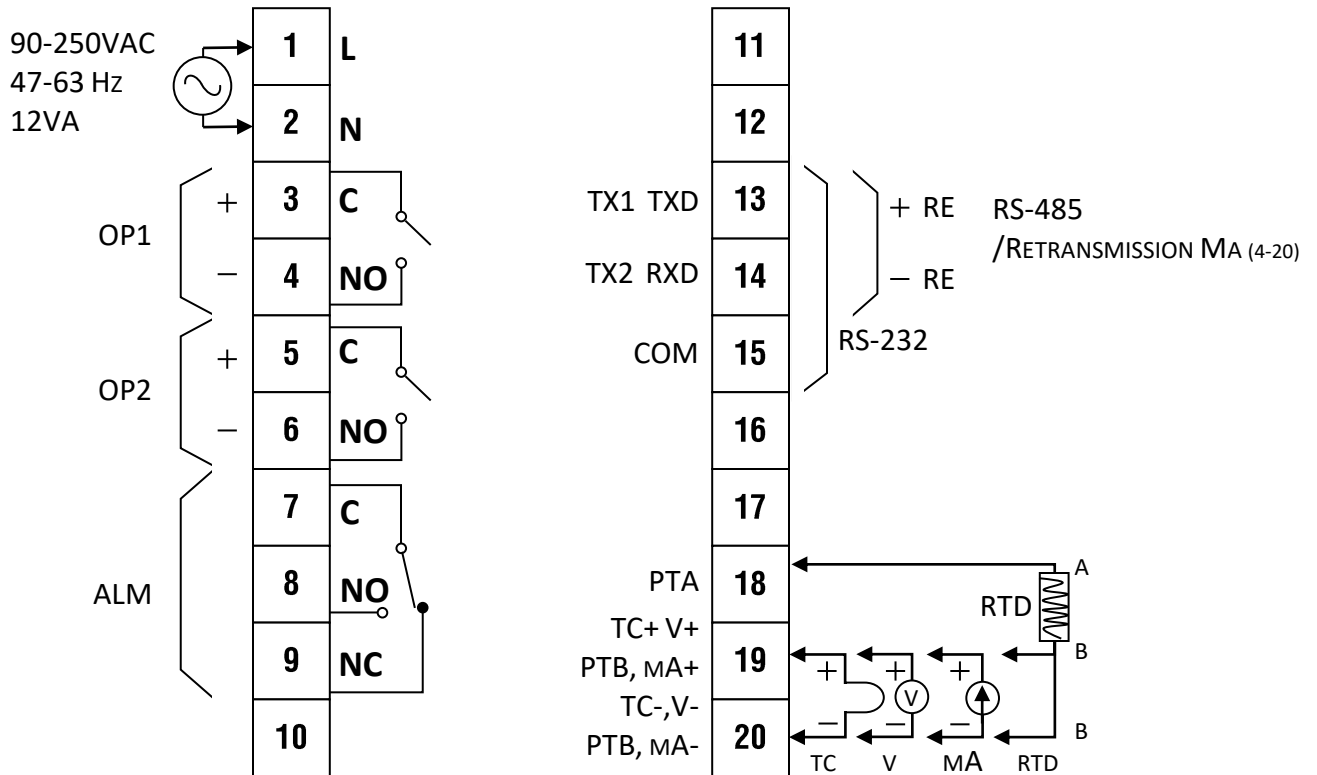

## FIGURE 2.4

### REAR TERMINAL CONNECTION FOR FDC-4100

#### A.C. POWER

#1 – BLACK

#2 – BLACK (230V) / WHITE (115V)

#### CONTROL REFRIGERATION SWITCH

#3 – BLUE OR RED (SINGLE STAGE)

#4 – BLUE OR RED

#### ALARM CIRCUIT

#7 – YELLOW

#8 – ORANGE

#### THERMOCOUPLE (Type "T")

#19 – BLUE ( COPPER )

#20 – RED ( SILVER )



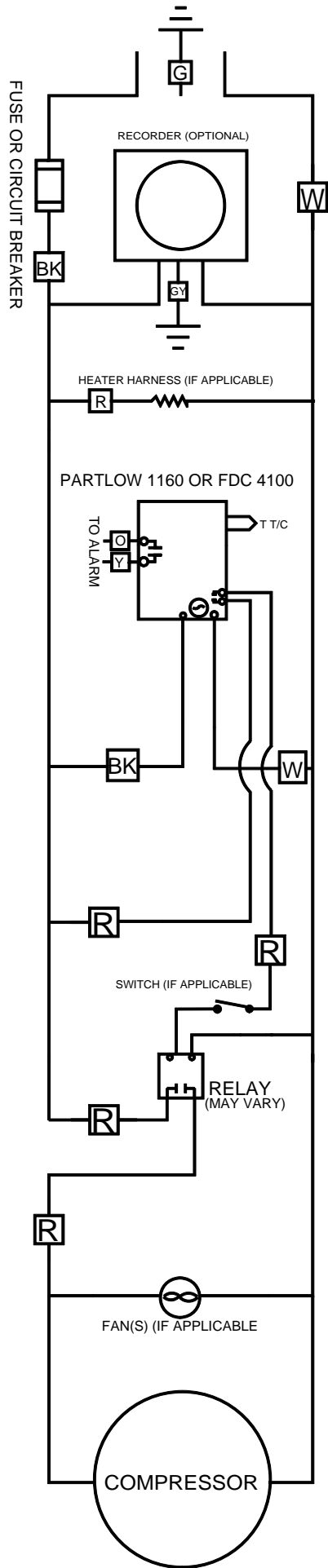

1160 / 4100 SS 115 VOLT

COLOR CODE CHART	
YELLOW	= Y
ORANGE	= O
BLUE	= B
RED	= R
WHITE	= W
GREEN	= G
BLACK	= BK
GREEN YELLOW	= GY

5-2010

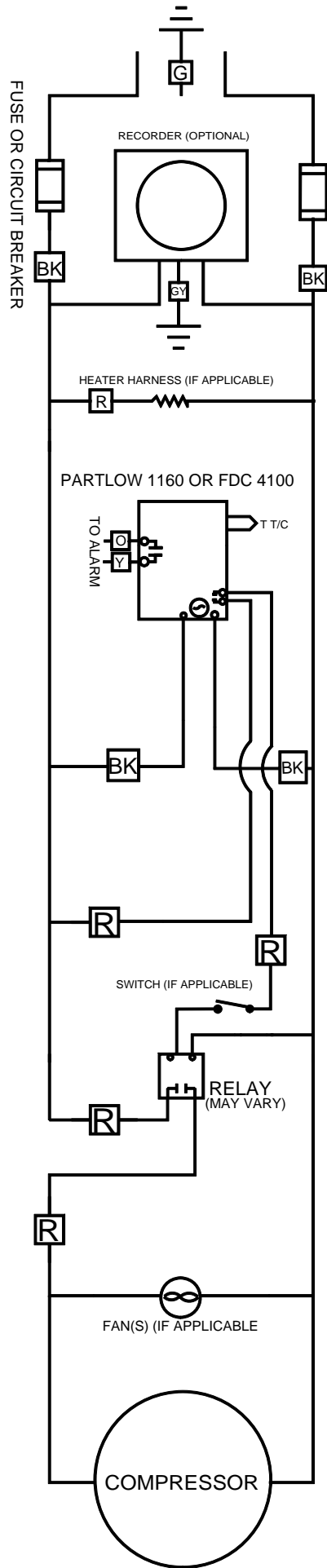

1160 - 4100 SS 230 VOLT

COLOR CODE CHART	
YELLOW	= Y
ORANGE	= O
BLUE	= B
RED	= R
WHITE	= W
GREEN	= G
BLACK	= BK
GREEN YELLOW	= GY

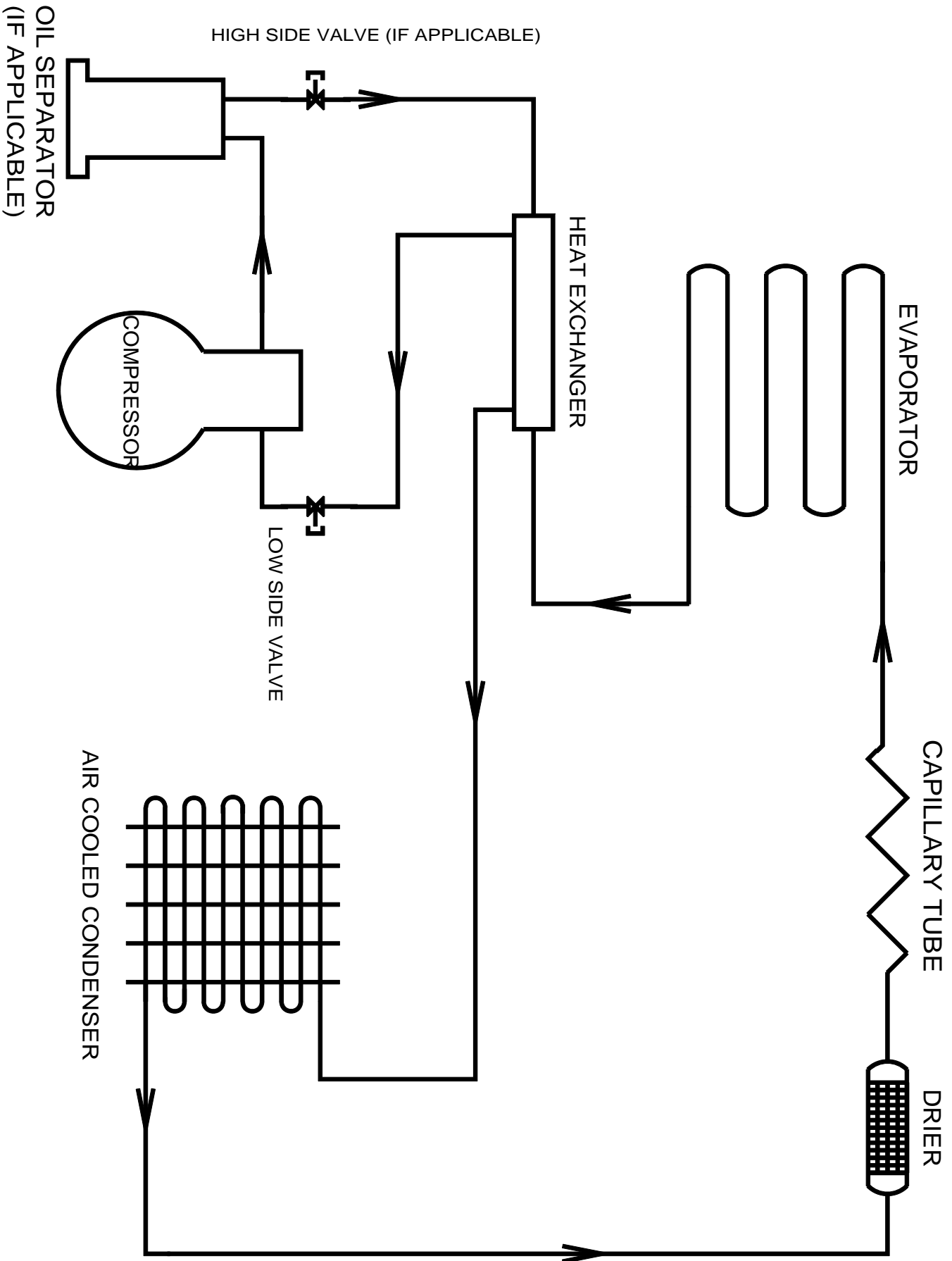

REFRIGERANT FLOW CHART

FLSS

PARTLOW 1160 / FDC4100

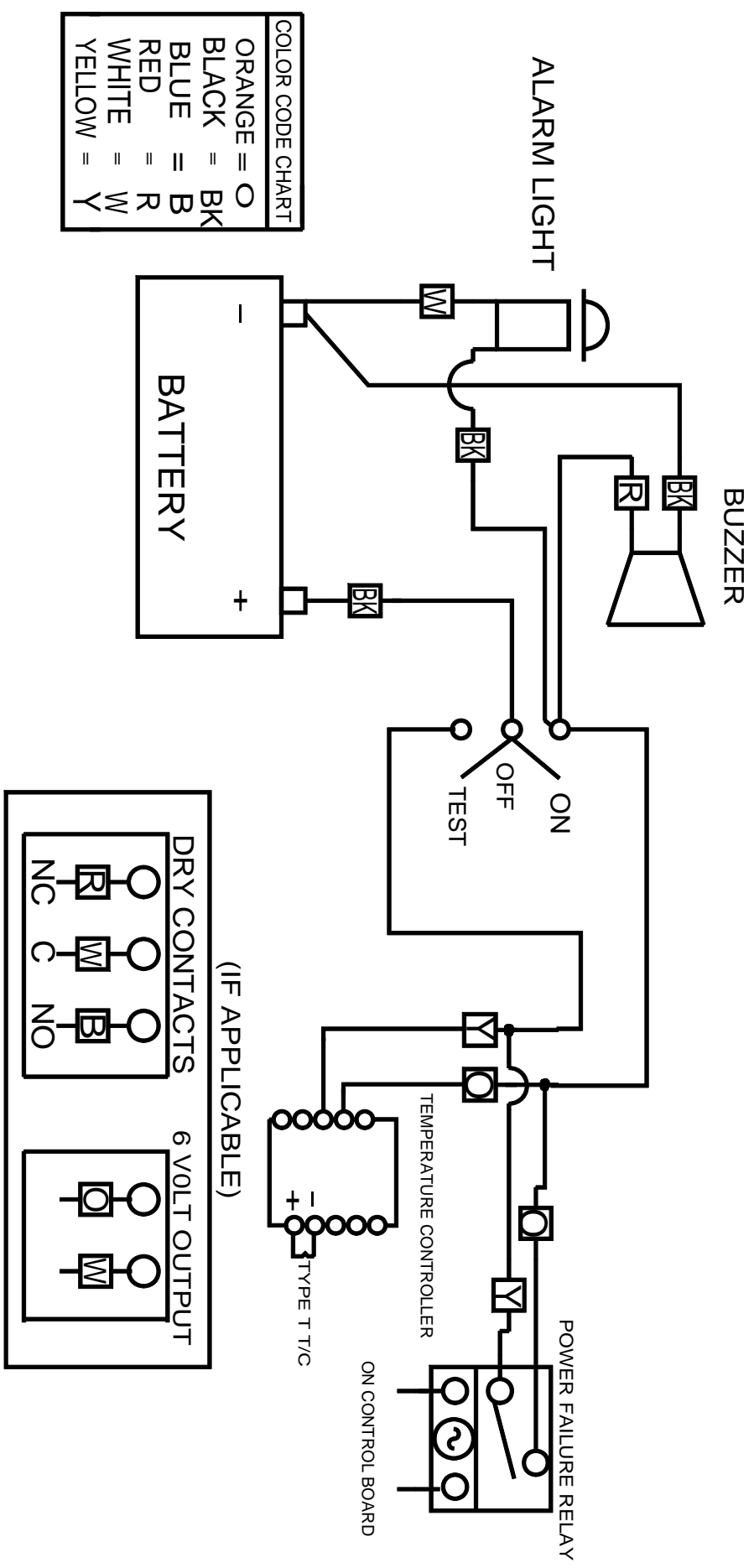

COLOR CODE CHART	
ORANGE =	O
BLACK =	BK
BLUE =	B
RED =	R
WHITE =	W
YELLOW =	Y



TO ENSURE YOU ARE PROVIDED THE CORRECT PARTS,  
THE **MODEL AND SERIAL NUMBER** OF YOUR UNIT  
MUST BE PROVIDED WHEN ORDERING.

COMPRESSOR MODEL	HP	VOLTAGE	HERTZ	PHASE	SO-LOW PART #
TECUMSEH AJB2433ZXA	1	115	50/60	1	<b>AJB24-115</b>
TECUMSEH AJB2433ZXD	1	208/220/230	50/60	1	<b>AJB24-208</b>
EMBRACO FFI12HBX	1/3	115	50/60	1	<b>FF12-115</b>
DANFOSS SC15FTX	1/3	115	50/60	1	<b>SC15-115</b>
DANFOSS SC18FTX	1/2	208/220/230	50/60	1	<b>SC15-208</b>

TEMPERATURE CONTROL PARTS	SO-LOW PART #
FDC 4100	<b>4100</b>
FDC 4000	<b>4000</b>
FDC nCOMPASS	<b>nCOMPASS</b>

CASCADE ELECTRICAL PARTS	SO-LOW PART #
Heater Harness No. H-200	<b>217-VOLTAGE</b>
Refrigeration Switch No. 2X464	<b>TOGGLE</b>
Condenser Fan Motor No. GE-5411 - 115/60/1	<b>500-115</b>
Condenser Fan Motor No. GE-5421 - 230/50-60/1	<b>500-VOLTAGE</b>
Electrical Cord No. 8-3 <b>(Please Specify Voltage)</b>	<b>PWRCRD-VOLTAGE</b>
Control Board No. CECB2TUV <b>(Please Specify Voltage)</b>	<b>231-VOLTAGE</b>

REFRIGERATION PARTS	SO-LOW PART #
Air Cooled Condenser No. 3CZ0602B	<b>254</b>
Heat Exchanger, No. HE-502	<b>HX-SS</b>
Drier No. C-052-S	<b>256L</b>
Capillary Tube No. CT-502	<b>SSC-23</b>
Oil Separator, Temprite Series 900 <b>(If Applicable)</b>	<b>900</b>

HARDWARE PARTS	SO-LOW PART #
Latch No. METL-L1-99	<b>REX37L1-3</b>
Chest Hinge	<b>59-928M</b>
Upright Hinge No. Polar 109-LH	<b>59-928U</b>
Cabinet Gasket	<b>NX504B1</b>
Lid or Door Gasket	<b>PSOS</b>
Grill No. 650H	<b>356F, 356S</b>
Sub-Lids <b>(Must have Model Number)</b>	<b>SL-MODEL NUMBER</b>
Inner Door <b>(Must have Model &amp; Serial Number)</b>	<b>357-MODEL NUMBER-SERIAL NUMBER</b>
Clips & Rollers for Inner Doors <b>(Quantity 10 minimum)</b>	<b>405</b>
Shelves for Freezer <b>(Must have Model Number)</b>	<b>4015-MODEL NUMBER</b>